



**ARTC**

**SJ23-0631-RPT-V1**

**Benalla Signal Hut  
Building Inspection Report**

**1<sup>st</sup> September 2023**






**ARTC**

---

105 Bakehouse Road  
South Kensington  
VIC 3031  
[www.sterling.com.au](http://www.sterling.com.au)

**RECORD OF DOCUMENT CONTROL**

REVISION	TASK	COMPANY	NAME	SIGNATURE	DATE
ARTC: Benalla Signal Hut – Building Inspection Report					
SJ23-0631_RPT01: V1.0					
Ver. 1.0	Authored	Sterling	Daniel McLeish		30/08/2023
	Reviewed	Sterling	Mehdi Lima		1/09/2023
	Approved	Sterling	Mehdi Lima		1/09/2023

**VERSION ADJUSTMENTS**

Version No.	Adjustment made	By Whom

## TABLE OF CONTENTS

EXECUTIVE SUMMARY .....	1
1 INTRODUCTION .....	4
1.1 GENERAL OVERVIEW .....	4
1.2 PROJECT SCOPE .....	4
1.3 LIMITATIONS/ EXCLUSIONS .....	4
2 METHODOLOGY .....	5
3 INSPECTION FINDINGS .....	6
3.1 GENERAL OBSERVATIONS.....	6
3.1.1 STRUCTURAL DESCRIPTION .....	6
3.1.2 STRUCTURAL FORM.....	7
3.2 ASSESSMENT.....	8
3.2.1 WALL CLADDING.....	8
3.2.2 ROOF.....	9
3.2.2.1 TRUSSES.....	9
3.2.2.2 SHEETING.....	10
3.2.2.3 FASCIA, GUTTER & ROOF LINING.....	11
3.2.3 STEEL ELEMENTS .....	13
3.2.3.1 EXTERNAL STAIRCASE AND STEEL COLUMNS.....	13
3.2.4 TIMBER FRAMEWORK .....	15
3.2.4.1 COLUMNS .....	15
3.2.4.2 EXTERNAL BEAMS.....	17
3.2.4.3 INTERNAL WALL ELEMENTS .....	19
3.2.4.4 INTERNAL TIMBER FLOORING AND CEILING .....	21
3.2.5 MASONRY AND CONCRETE FOOTINGS.....	24
3.2.6 INTERNAL STEEL ELEMENTS AND SIGNALLING LEVER FRAME AND ASSOCIATED SIGNALLING EQUIPMENT.....	27
3.3 DEFECTS.....	31
3.3.1 EXTERNAL DEFECTS .....	31
3.3.2 INTERNAL DEFECTS.....	44
3.4 ACCESS TO THE PUBLIC AND ADJACENT RAILWAY LINE.....	49
3.5 REDUCED STRUCTURAL CAPACITY DUE TO VEHICLE IMPACT .....	49
4 RECOMMENDATIONS.....	50

4.1 RECOMMENDED APPROACH..... 50

List of Appendices	
Appendix A	Drawings

## EXECUTIVE SUMMARY

Australian Rail Track Corporation (ARTC) have advised that as part of the Inland Rail Program, significant track realignment work will be required, and as such the viability of the Benalla Signal Hut (signal hut) is in conflict with future rail and pedestrian infrastructure due to clearance and sight distance issues. Sterling understand that the signal hut is currently non-functional and the asset owner is Victrack. ARTC have engaged Sterling Infrastructure Pty Ltd (Sterling) to undertake a visual inspection of the signal hut to assess its current structural condition and provide advice regarding the feasibility of re-purposing salvageable portions of the signal hut.

Access was gained to the structure on 12<sup>th</sup> July 2023, and all accessible and visible areas were inspected. Access to the first floor of the building was restricted due to the structural damage resulting from an accidental vehicle collision on the north-west corner of the signal hut (see figure 3.3A). As a result, only certain segments of the first floor could be inspected safely. A visual inspection of the unsafe areas on the first floor was conducted from the designated safe zones of the first floor. In addition to the limited access for the first floor, the structural arrangement of the roof truss system was not visible from the first floor due to the presence of a timber ceiling obstructing the view. To overcome this limitation, holes were drilled in the ceiling and a cable with a camera attached to it was used to visually inspect the hidden areas. Despite these measures, the limited visual inspection method could not provide a complete assessment of the overall condition.

The inspection identified numerous severe structural deficiencies, including but not limited to:

- The building's north-west corner and northern elevation sustained significant structural damage resulting from an assumed accidental vehicle impact collision. This damage included the failure of one of the four timber columns and the internal wall timber members on the northern side. Consequently, a specific section of the first floor was left cantilevering due to the severity of the impact;
- The external timber beam supporting the first floor toilet exhibited severe splitting and was noticeably out of alignment, potentially attributed to the settlement of the timber column supporting it on the south-west side;
- Severe surface corrosion was observed on the square hollow section (SHS) column supporting the external beam of the first floor toilet;
- The main timber column of the building at the southwest corner was found to be severely split;
- A fallen/disused drainage pipe was observed on the ground adjacent to the Upside elevation;
- Localised pitting corrosion was observed on the Parallel Flange Channel (PFC) sections where connections with the staircase treads were constructed;
- Surface corrosion was found throughout the external staircase and landing during the inspection;
- Delamination was observed between the PFC sections and the platform landings, with a particular prominence on the primary landing area;
- The external lining of the roof exhibited splitting in certain areas, accompanied by peeling paint from the members;
- The timber fascia of the signal hut displays severe splitting and, in certain sections, shows signs of rot. Additionally, there are indications of delamination between the roof sheathing and fascia in some areas;

- Several internal timber members exhibited severe splits, and one of the internal timber members had structurally failed, likely due to the presence of termites;
- Cracking was observed in the concrete foundation of the structure.
- Localised displacement of the corrugated steel roof sheeting and loose sheets and ridge flashing was observed
- The timber-framed windows on the Down-Side elevation were severely split and rotted in certain sections.

The severity and extent of the defects identified on-site to the signal hut pose an unacceptably high risk of injury to anyone accessing the building, and as such **signage must be set up as soon as possible to warn of hazard and instruct not to enter**. In addition to the warning signage being installed, fencing is required to prevent access to the stairs and the doors. Furthermore, the loose ridge capping must be removed as soon as possible to prevent risk of it falling and causing injury.

During the inspection, controlled and cautious attempts were made to traverse the first floor of the building. However, the significant structural damage caused by a vehicle impact collision led to an adjustment in the Sterling hazard assessment, allowing safe access to only a very small section of the first floor.

In addition to the risk posed to pedestrian access, there is also a risk of the signal hut collapsing onto the adjacent train line in the future. Due to the severity of the consequence should this risk eventuate we advise that action must be taken with appropriate urgency. Props need to be installed **as soon as possible** to provide vertical support in lieu of the failed column and wall members on the impacted northern elevation. Additionally **demolition or dismantlement must commence within 6 months**. If the signal hut cannot be demolished or dismantled within the 6 month time frame, a follow up inspection will be required which may necessitate additional safety measures such as strengthening work until rail occupation allows for demolition or dismantlement.

It is possible to salvage and re-purpose portions of the signal hut as listed in Table 1. The remaining elements should be recycled if re-purposing is not possible following closer and more intrusive investigation, particularly in relation to termite infestation into the timber elements.

### Benalla Signal Hut - Component Summary

Structural Element	% Salvageable	Suitable for structural re-use	Recommendation
External steel cladding	<70%	Potentially subject to testing	Re-cycle or Re-purpose (subject to testing)
Timber roof trusses	Unknown	Potentially subject to testing	Re-cycle or Re-purpose (subject to testing)
Corrugated steel roof sheeting	<70%	Potentially subject to testing	Re-cycle or Re-purpose (subject to testing)

Fascia, gutter and roof soffit	<80%	Potentially subject to testing	Re-cycle or Re-purpose (subject to testing)
External steel staircase stringers and steel columns	<80%	Potentially subject to testing	Re-cycle or Re-purpose (subject to testing)
Timber wall members	<70%	Potentially subject to testing	Re-cycle or Re-purpose (subject to testing)
External timber beams	<60%	Potentially subject to testing	Re-cycle or Re-purpose (subject to testing)
Internal timber wall and floor elements	<70%	Potentially subject to testing	Re-cycle or Re-purpose (subject to testing)
Internal timber ceiling	<90%	Potentially subject to testing	Re-cycle or Re-purpose (subject to testing)
Masonry and concrete upstands	<30%	No	Dispose
Internal steel elements	100%	Potentially subject to testing	Re-cycle or Re-purpose (subject to testing)
Internal signalling lever frame , interlocking, rodding and associated equipment	100%	No	Salvage and preserve either on display within the Station precinct or donate to a Museum or local railway or historical community group after seeking specialist advice.

*Table 1 – Component condition and re-purpose recommendation summary*

Given the percentage of materials which are non-salvageable we advise that relocating the signal hut is not practicable and cost effective.

## 1 INTRODUCTION

### 1.1 GENERAL OVERVIEW

Sterling was engaged by ARTC to conduct a visual structural assessment of the signal hut. The inspection was carried out on 12/07/2023.

The assessment consisted of the determination of the construction type, and identification of all visible/accessible defects or signs of potential distress, damage, or deterioration on all accessible components of the building. This information has been used to identify areas and elements of the building which pose a safety risk and/or require temporary make safe works and to provide recommendations to ARTC regarding the potential re-purposing of portions of the signal hut.

### 1.2 PROJECT SCOPE

The scope included:

- Visual structural inspection of Benalla Signal Hut
- Structural Report which includes:
  - Non-Intrusive Inspection observations and defect descriptions
  - High-level defects list identified during the inspections
  - Photographic evidence of each defect; and,
  - Recommended remedial repair work.
  - Assessment and recommendations regarding potential re-purpose of components of the signal hut.
- Drawing Set including:
  - Site Plans including relevant adjacent features within 10m
  - Floor plan and elevations with approximate dimensions
  - Annotations describing the external building material
  - Any internal or external features (eg: plumbing fixtures & fittings, electrical fittings, built in fixtures or fittings, etc).

### 1.3 LIMITATIONS/ EXCLUSIONS

Inspections were conducted from ground level only and in accessible and visible areas only. The scope of the inspection was visual only; opening and access into concealed and confined areas were excluded from the scope of the inspection methodology.

- ⊖ Access to the top surface of the roof was not possible, and therefore has not been inspected in any detail other than visual examination from ground level.
- Due to the significant vehicle impact damage to the supporting floor members below, only specific areas of the first floor were traversed during the inspection.
- Geotechnical investigations were excluded from the scope;
- Material testing were excluded from the scope;
- Termite diagnostic testing.



The scope of the inspection excluded the following items.

- Assessment of operational performance of building utilities and services, beyond the identification of obvious visual damage during the general building inspection was excluded.
- Review of existing drawings: existing construction documents and building reports, and proposed refurbishment and extension plans were not made available for review.
- Any destructive/non-destructive testing of structural materials such as timber drilling (with the exclusion of timber drilling to insert a miniature camera through the ceiling for inspection of the roof trusses).

## 2 METHODOLOGY

As per the guidance and directives of a Track Force Protection Coordinator, (TFPC), a team of two highly experienced Structural Engineers specialized in building inspections conducted a comprehensive visual assessment of the signal hut. The inspection covered all accessible areas of the structure that were identified as safe for entry.

The inspection was conducted from ground level, covering both levels of the structure. All significant defects were photographed, and relevant measurements were taken to assess their magnitude and severity.

Site measurements were undertaken using a combination of tape measure and disto-meter. The dimensions were recorded on preliminary sketches prepared by Sterling based on available site images prior to mobilising.

To aid in observing defects that were beyond reach from ground level, a Go-Pro camera attached to an extension pole was utilised during the inspection process. This allowed the inspection team to capture detailed footage and closely examine areas that were not easily accessible.

### 3 INSPECTION FINDINGS

#### 3.1 GENERAL OBSERVATIONS

##### 3.1.1 STRUCTURAL DESCRIPTION

The building in question is a two-storey structure situated adjacent the level crossing on Nunn St and adjacent the intersection with Mackellar Street. The building has a plan area of 32.8m<sup>2</sup>. It was formerly utilised as a signal hut for the adjacent railway tracks but is now disused.



Figure 3-1: Aerial image of the signal hut



Figure 3-2: Benalla Signal Hut

### 3.1.2 STRUCTURAL FORM

The site investigation confirmed that the building is a two-storey timber-framed structure supported on masonry brick and concrete footings, with steel faux-weatherboard cladding and corrugated steel roof sheeting. Sterling estimates that the date of original construction was in the 1870s, and on this basis the metal cladding is unlikely to have been part of the original signal hut.

From the limited visual inspection that was possible of the duo-pitched roof structure to the main building footprint, it was noted that it consisted of timber trusses supporting timber purlins and corrugated steel roof sheeting.

The ground floor consisted of a concrete surface, while the first floor consisted of timber deck planks spanning between timber floor joists.

The duo-pitched roof falls North-South from a central ridge. Overlying the first floor timber sash type windows to the north elevation is a small mono-pitched roof with steel corrugated roof sheeting to provide weather protection.

Internally, the ground floor consisted of a single space heavily cluttered with the steel signalling lever frame and numerous shelving units with old disused electronic equipment. On the first floor, there were two separate rooms. The south elevation had a separate room at the top of the staircase, which served as a toilet. The first room on the first floor was empty with the exception of the signalling levers commonly referred to as the 'Operating Room' or 'Lever Room'. The flooring in both rooms consisted of timber deck planks spanning between timber joists. Additionally, a timber ceiling was present in both rooms, which obstructed a visual inspection of the structural form of the roof.

External eave gutters on the Up-Side collect roof drainage and direct it to a downpipe. The bottom half of this down-pipe has fallen off and is currently lying adjacent to the building.

No existing documentation was made available for this building.



Figure 3-3 – Benalla Signal Hut (South-East corner)



*Figure 3-4A – Benalla Signal Hut (North West Corner)*

## **3.2 ASSESSMENT**

### **3.2.1 WALL CLADDING**

Overall, the wall cladding around the full perimeter of the structure consists of steel faux-weatherboard cladding, which was found to be in reasonable condition. However, there was severe damage to the cladding in the area impacted by the vehicle collision.



*Figure 3-5: Section of external cladding that has been damaged beyond repair.*



*Figure 3-6: General condition of steel weatherboard cladding*

The steel faux-weatherboard cladding is unlikely to be original as these type of signal boxes were usually clad with timber weatherboarding.

It is theoretically possible to remove the faux weatherboard cladding, and extract the salvageable portions for re-purposing and discard the non-salvageable elements.

## **3.2.2 ROOF**

### **3.2.2.1 TRUSSES**

A visual inspection of the timber roof structure was not possible due to a timber ceiling been in place above the first floor. To facilitate some form of visual inspection, holes were drilled in the ceiling, and a cable with a camera attached to the end was fed through the holes. The images obtained from this device revealed that the structural form of the roof consisted of closely spaced timber trusses, supporting timber purlins, which in turn supported the corrugated steel roof sheeting. From the limited observation through the camera device, the timber trusses appeared to be in fair condition. However, due to the restricted access, a comprehensive assessment of the roof's structural integrity could not be conducted.



Figure 3-7: Image of closely spaced timber roof trusses on device

It is theoretically possible to remove the timber trusses and extract the salvageable portions for re-purposing and discard the non-salvageable elements.

### 3.2.2.2 SHEETING

The roof sheeting was found to be in generally fair condition, displaying localised signs of deformation, disconnection, surface corrosion, and deterioration. Additionally, a portion of the roof sheeting was completely missing, presumed to have fallen off the structure. Notably, there was a section of the ridge of the roof that had become disconnected and remained on top of the roof, exacerbating the structural and safety issues with the structure.



Figure 3-8: Section of roof sheeting missing and section of the roof ridge on top of the roof



Figure 3-9: Deformed section of the roof sheeting on the lower portion of the roof



Figure 3-10: Deterioration of protective coating system on roof sheeting

The loose ridge capping poses an extreme safety hazard due to risk of it falling either onto the adjacent railway track or onto a pedestrian. **Due to the risk of the roof sheeting falling laterally or getting blown in the wind onto one of the adjacent railway tracks, the sections of the roof that are completely disconnected should be retrieved as soon as possible to prevent any collision with passing trains.**

It is theoretically possible to remove the roof sheeting, and extract the salvageable portions for re-purposing and discard the non-salvageable elements.

### 3.2.2.3 FASCIA, GUTTER & ROOF LINING

During the visual inspection, it was evident that both the timber fascia and roof lining exhibited signs of weathering, and the protective paint coating had significantly deteriorated. In specific sections of the fascia, severe splitting and signs of rotting were observed, posing potential hazards. Additionally, some fascia members were found to be disconnected, raising concerns about possible detachment and falling. The roof lining showed considerable splitting in certain areas, further contributing to the degradation of the overall structure. Generally the gutter appeared to be in relatively fair condition based on the visual inspection conducted from ground level and as with the wall cladding, appeared to have been replaced at some point in the building's history.



*Figure 3-11: Significant splitting and deterioration of the fascia member*



*Figure 3-12: Disconnected fascia member and deterioration of the roof lining*





*Figure 3-13: Deteriorated fascia member*

Certain sections of the timber fascia pose a safety hazard due to their instability and risk of disconnection. For this reason an exclusion zone is required to be set up to prevent pedestrian access. Due to the risk of the gutter or fascia falling laterally the exclusion zone should be erected several meters away from the building line. Given the location of the signal hut with respect to the live railway tracks, further provisions should be made to ensure that no debris falls onto the tracks and causes disruption to any passing trains.

It is theoretically possible to remove the fascia, and extract the solid portions of timber for re-purposing and discard the non-salvageable elements.

### **3.2.3 STEEL ELEMENTS**

#### **3.2.3.1 EXTERNAL STAIRCASE AND STEEL COLUMNS**

The external staircase was found to be in a reasonable condition; however, signs of deterioration were evident during the inspection. These signs included surface corrosion, localised pitting corrosion observed at the locations of PFC members and stair thread connections, and delamination of the connection between the stairs landing and PFC members.



*Figure 3-14: General surface corrosion on one of the PFC members of the external staircase*



*Figure 3-15: Pitting corrosion on one of the PFC members on the external staircase*

It is theoretically possible to remove the steel stair structure, and extract the salvageable portions for re-purposing and discard the non-salvageable elements.

### **3.2.4 TIMBER FRAMEWORK**

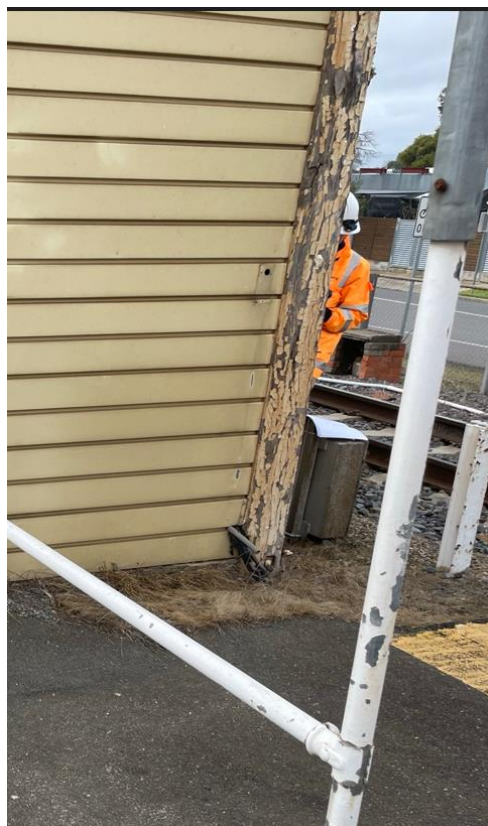
#### **3.2.4.1 COLUMNS**

One column on the northern elevation has been destroyed, presumably due to vehicular impact.

The condition of the timber columns of the signal hut can be categorized into two distinct groups. The columns on the east side of the structure were generally in fair condition, showing reasonable structural integrity. However, the columns on the west face of the structure were in poor condition, displaying signs of significant deterioration.

The column located at the south-west of the structure was severely split, indicating compromised structural integrity. Furthermore, there was notable deterioration in its protective coating system, leaving it vulnerable to further degradation. Similarly, the column situated at the north-west of the structure exhibited similar defects as previously mentioned, with additional damage caused by the vehicle collision impact on the north face of the building.

During the visual inspection, it was observed that one timber column supporting the first floor toilet had experienced minor settlement. The settlement was noticed due to the unsymmetrical appearance of the external timber beam it was supporting. Furthermore, the column showed minor signs of splitting and deterioration in its protective coating system.



*Figure 3-16: Severe splitting and deterioration of protective coating system on south-west column*



*Figure 3-17: General photo of main column on the south-east corner of the building*



*Figure 3-18: Main column impacted by the accidental impact load*

The severity of the column defects poses a significant risk to the global stability of the signal hut.

The severe splitting and impact damage to the columns at the west side of the structure have reduced the column section capacity significantly and it is considered unlikely that these columns would retain sufficient capacity to comply with the design loads of the current Australian Standards.

Rectification would involve temporary propping works to ensure the signal hut remains stable during extraction and replacement of adversely affected column segments.

The works would also likely involve a footing assessment and potentially pouring new footings or underpinning the existing footings.

The cost and complexity of this work is high, and would involve both structural and geotechnical design as well as temporary works specialists. The proximity of the structure to the rail track adds a significant constraint to ensure the works can be undertaken safely.

It is theoretically possible to remove the columns from the signal hut, and extract the solid portions of timber for re-purposing and discard the weakened and/or rotten elements.

#### **3.2.4.2 EXTERNAL BEAMS**

During the inspection, the external timber beams supporting the first-floor toilet were found to be in poor condition. Both beams exhibited severe splitting, indicating a compromised structural integrity. Additionally, there was notable deterioration of their protective coating, leaving the timber vulnerable to further degradation.



*Figure 3-19: Non horizontal external beam supporting first floor toilet*



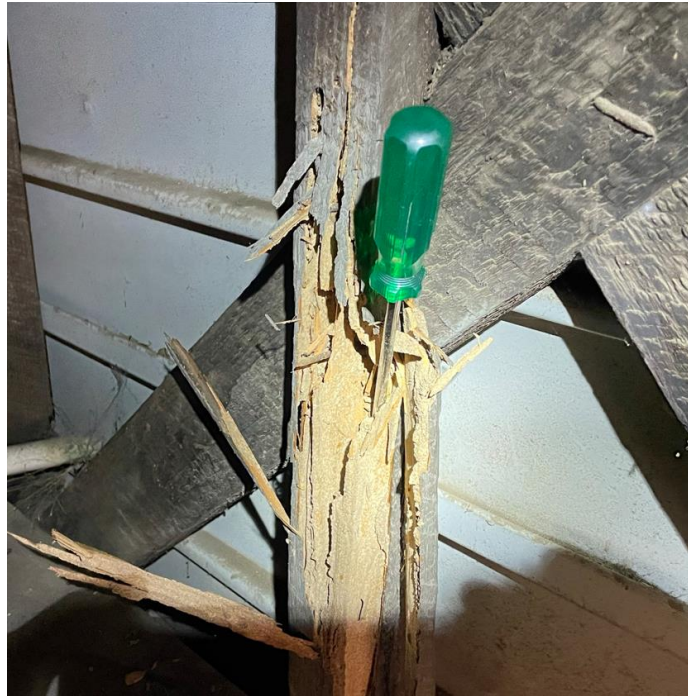
*Figure 3-20: Split in external beam supporting first floor toilet*

The reduced structural capacity of the external beams in the signal hut raises significant concerns regarding the vulnerability of the associated first-floor area to potential structural failure. To rectify this issue, temporary propping works would be required to ensure the stability of the signal hut during the extraction and replacement of the affected beam segments. However, the cost and complexity of this work are substantial, involving the expertise of structural engineers and temporary works specialists. Additionally, the proximity of the structure to the rail track presents challenges in ensuring the safe execution of the works.

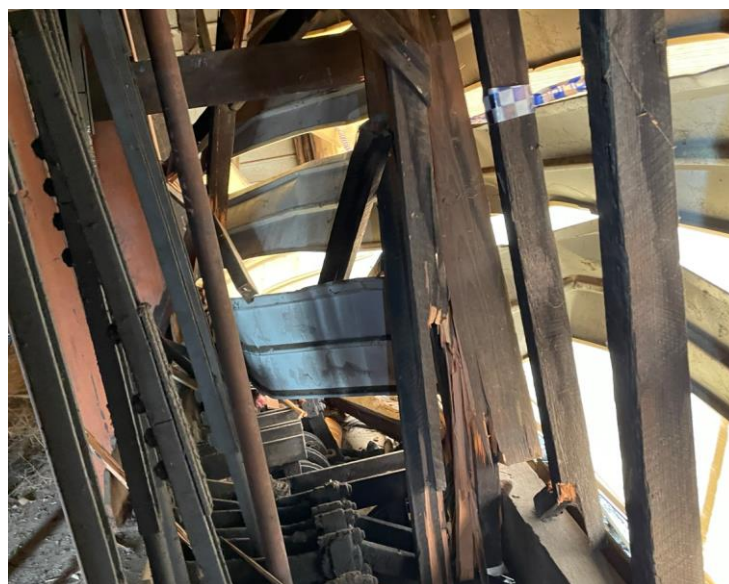
It is theoretically possible to remove the external beams from the signal hut, and extract the solid portions of timber for re-purposing and discard the weakened and/or rotten elements.

### 3.2.4.3 INTERNAL WALL ELEMENTS

Overall, the internal wall framing elements of the building were in fair condition, with the exception of those directly impacted by the vehicle collision, which were damaged beyond repair. Additionally, one particular mullion on the western elevation was found to have structurally failed, likely due to the presence of termites. It is worth noting that some other members showed minor splits, but these were considered minor defects.



*Figure 3-21: Structurally failed member due to the possible presence of termites*



*Figure 3-22: Structurally failed column and mullions due to impact collision*



*Figure 3-23: Structurally failed column due to impact collision*



*Figure 3-24 Structurally failed members due to impact collision*

The current condition of the internal wall members, having been impacted by a vehicle, poses a risk to the signal hut's stability. Furthermore, the structural failure of one member due to possible termite presence suggests that other members may also be affected. Rectification measures would involve temporary propping works to ensure the stability of the signal hut during the extraction and replacement of adversely affected segments. Moreover, the proximity of the structure to the rail track presents a significant challenge to ensure safe execution of the works.

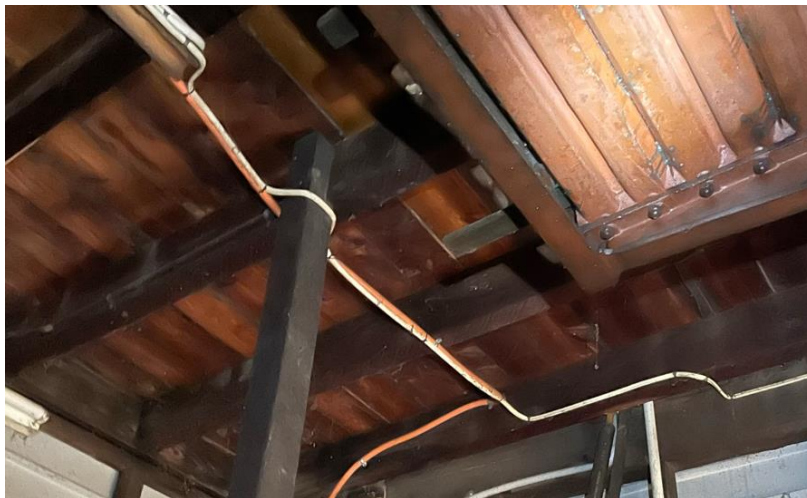


It is theoretically possible to remove the internal wall elements from the signal hut, and extract the solid portions of timber for re-purposing and discard the weakened and/or rotten elements.

#### 3.2.4.4 INTERNAL TIMBER FLOORING AND CEILING

The overall condition of the timber beams, decking, and ceiling elements on the first floor was assessed to be in fair condition. However, there were some notable observations during the inspection. Certain timber beams supporting the first floor were not spanning continuously from adjacent supports, and it appeared that a middle portion of the beam had been purposely cut out, likely for a specific purpose.

Additionally, the timber ceiling elements on the first floor showed some minor splits and minor deterioration of the protective painting system.



*Figure 3-25: Underside of timber beams and deck flooring of the first floor*



*Figure 3-26: Missing middle section of timber beam of first floor*



*Figure 3-27: Timber ceiling adjacent to first floor toilet*



Figure 3-28: Timber walls for first floor toilet



Figure 3-29: First floor Operating Room



*Figure 3-30: timber ceiling to first floor*

It is theoretically possible to remove the internal timber flooring and ceiling from the signal hut, and extract the solid portions of timber for re-purposing and discard the weakened and/or rotten elements.

### **3.2.5 MASONRY AND CONCRETE FOOTINGS**

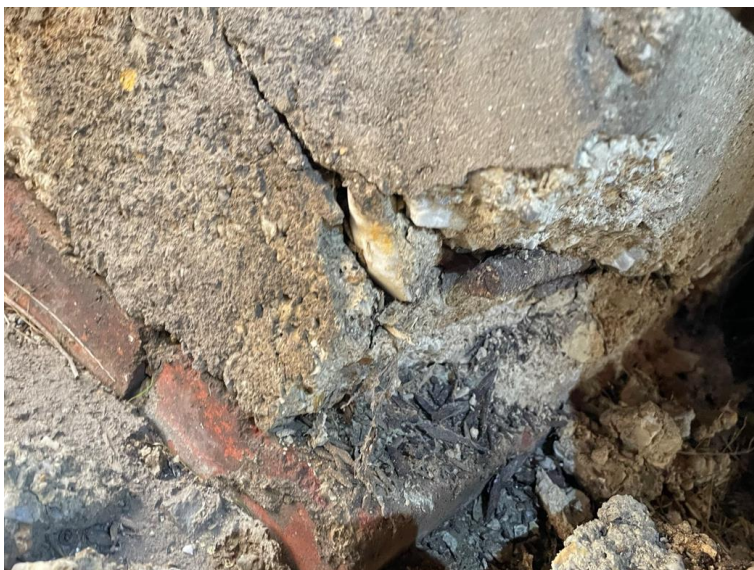
Overall, the masonry and concrete footings of the structure were found to be in fair condition during the inspection. However, there was one specific area of the masonry and concrete footing that was in poor condition. This section of the footing was missing a chunk of concrete, cracked and had exposed reinforcement that was corroded. This damage was likely caused by durability issues and potentially poor construction techniques. Regarding the remaining sections of the concrete and masonry footings, minor cracking and concrete spalling were observed on certain areas.



*Figure 3-31: General photo of concrete footing on masonry bricks*



*Figure 3-32: Missing piece of the concrete footing*



*Figure 3-33: Cracked piece of concrete upstand with exposed rebar*

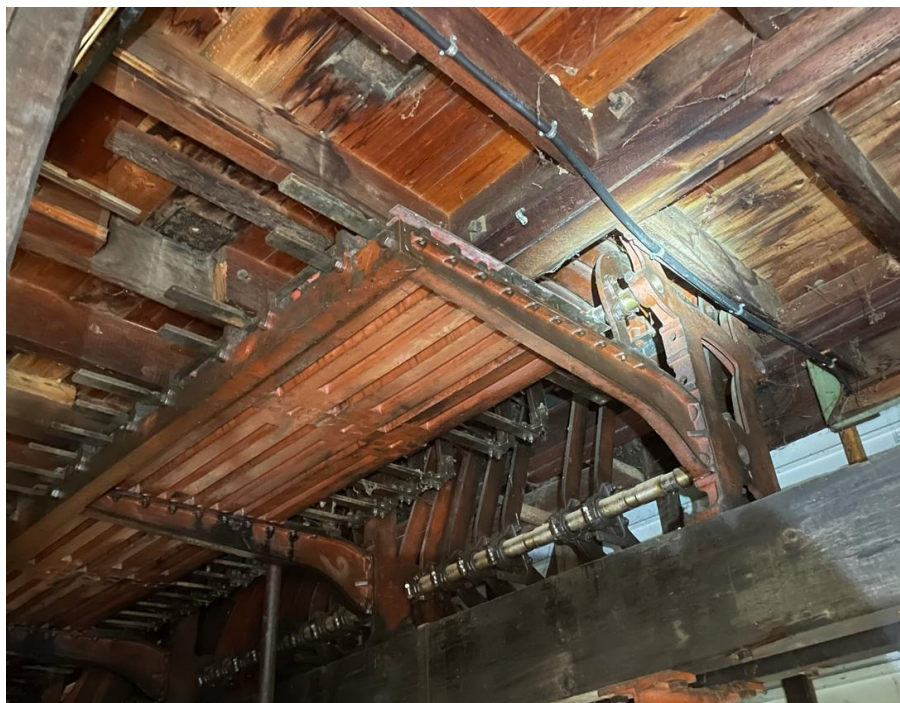
Based on the findings of the inspection, an engineering judgement has been made, and it is not recommended to repurpose any of the concrete and masonry upstands from the existing signal hut and these should be appropriately recycled.

### 3.2.6 INTERNAL STEEL ELEMENTS AND SIGNALLING LEVER FRAME AND ASSOCIATED SIGNALLING EQUIPMENT

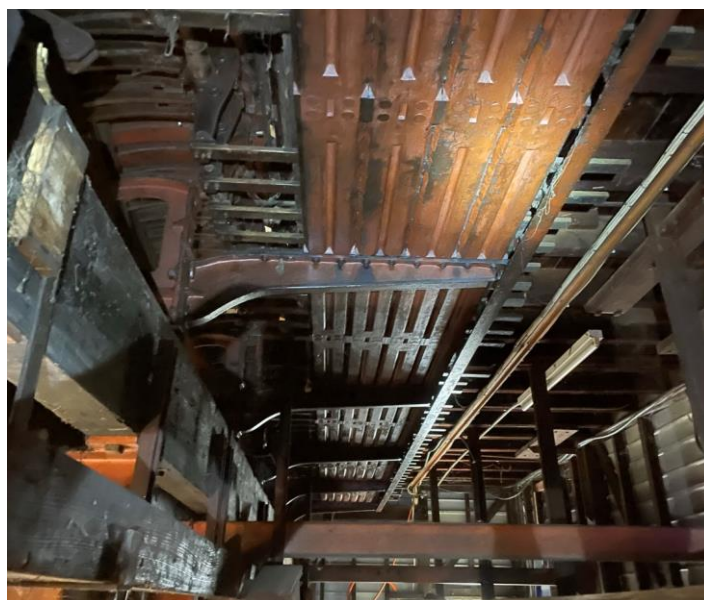
The internal steel elements observed in the signal hut were generally found to be in fair condition during the inspection. These elements exhibited no significant signs of deterioration or structural concerns. Furthermore, the signalling lever frame and associated equipment and levers was also in good condition. It showed no visible signs of damage.



*Figure 3-34: Signalling lever frame and associated equipment*

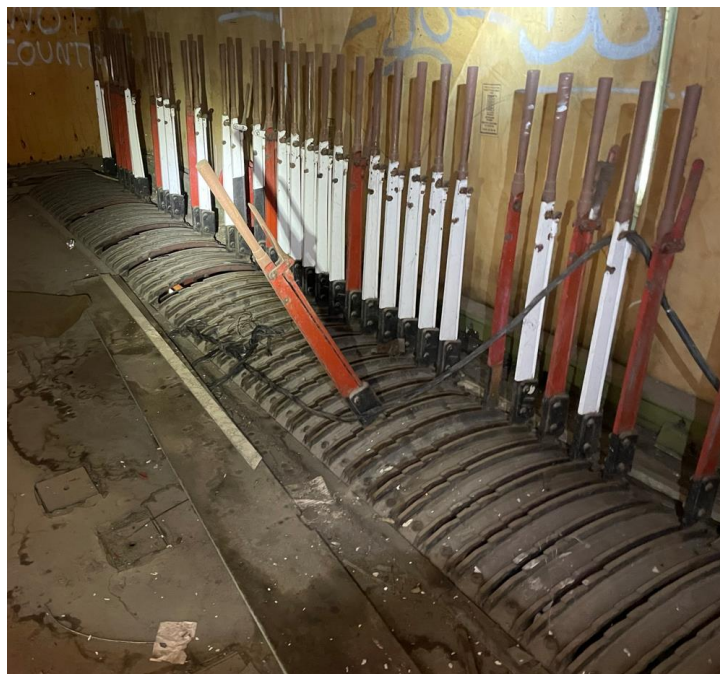


*Figure 3-35: 336 Signalling lever frame and associated equipment*



*Figure 3-37: 338 Signalling lever frame and associated equipment*





*Figure 3-39: Signal levers within the Operating Room*



*Figure 3-40: Internal steel lever frame supporting first floor elements*





*Figure 3-41: Internal steel lever frame supports*



In regard to the internal steel elements including columns and beams found in the building, it is possible that these materials could be re-purposed. Due to the historical value of these elements, careful consideration of the re-purposing should be undertaken, which could involve offering them to historical railway societies or museums.



**3.3 DEFECTS**



The inspection identified a total of 41 No. defects throughout the internal and external areas of the building. The following section describes all defects identified during the inspection.



**3.3.1 EXTERNAL DEFECTS**



REF	DEFECT DESCRIPTION	PHOTO
<b>FACADE</b>		
1	North elevation of the structure that was impacted by a vehicle collision	
2	Steel wall cladding that has been damaged beyond repair by impact damage	

REF	DEFECT DESCRIPTION	PHOTO
3	Steel wall cladding and internal timber wall members damaged beyond repair by impact damage	 A close-up photograph showing significant damage to the interior wall structure. The yellow-painted steel wall cladding is cracked and peeling. Below it, the internal timber wall members are severely damaged, splintered, and broken, with some wood exposed and charred.
4	Steel wall cladding and internal timber wall members damaged beyond repair by impact damage	 A wider-angle photograph of the same interior wall area. It shows the extent of the damage to the yellow steel cladding and the underlying timber structure. The timber is heavily splintered and broken, and the steel cladding is severely distorted and damaged.

REF	DEFECT DESCRIPTION	PHOTO
5	Splitting and deterioration of protective coating of timber framed windows on north elevation of structure	
6	Splitting and deterioration of protective coating of timber framed windows on north elevation of structure	




REF	DEFECT DESCRIPTION	PHOTO
7	Splitting and deterioration of protective coating of timber framed windows on north elevation of structure	
<b>COLUMNS</b>		
8	Severe splitting and deterioration of protective coating system on main timber column on south-west corner of structure	




REF	DEFECT DESCRIPTION	PHOTO
9	Splitting of timber column and deterioration of protective coating system on south-west corner of structure	
10	Splitting of timber column and deterioration of protective coating system on south-west corner of structure	



REF	DEFECT DESCRIPTION	PHOTO
11	Main timber column member on the north-west corner of the structure affected by the impact damage	
12	Column on northern elevation has been destroyed, presumably by vehicle impact.	

**ROOF - SHEETING**








REF	DEFECT DESCRIPTION	PHOTO
13	Section of the corrugated steel roof sheeting missing, and section of the roof ridge displaced and on top of the roof	
14	Deformed corrugated steel roof sheeting on the lower portion of the roof	
15	Deterioration of the protective coating on the underside of the lower portion of the roof	
<b>EXTERNAL BEAMS</b>		



REF	DEFECT DESCRIPTION	PHOTO
16	Non-horizontal beam supporting the first floor toilet	
17	Severe splitting in the external timber beams supporting the first floor toilet and deterioration of the protective coating system	
<b>FASCIA, GUTTER AND ROOF SOFFIT</b>		
18	Significant splitting and deterioration of the timber fascia member	



REF	DEFECT DESCRIPTION	PHOTO
19	<p>Disconnected timber fascia member and, splitting and deterioration of the protective coating system of the roof soffit members</p>	
20	<p>Splitting and deterioration of the protective coating system</p>	

**EXTERNAL STAIRCASE AND STEEL COLUMNS**


REF	DEFECT DESCRIPTION	PHOTO
21	<p>General surface corrosion that was present of the external staircase</p>	 <p>A photograph showing a vertical metal member of an external staircase. The metal is heavily corroded, appearing brown and flaking. A yellow measuring tape is placed vertically against the member. To the right, there is a sign with a white top half and a green bottom half, with some handwritten text. A blue pen lies on the ground next to the member. A person wearing an orange high-visibility vest is partially visible on the left.</p>
22	<p>Pitting corrosion located on PFC member of external staircase where stair thread was connected to member</p>	 <p>A close-up photograph of a metal member, likely a PFC (Pre-Fabricated Concrete) member, showing significant pitting corrosion. The surface is dark brown and heavily eroded. A metal rod or tool is inserted into a hole in the metal, highlighting the depth of the corrosion. The surrounding area is also stained with rust.</p>

REF	DEFECT DESCRIPTION	PHOTO
23	Surface corrosion of external SHS column section supporting first floor toilet	
24	Fallen drainage pipe	
25	Delamination of the connection between the PFC member and the steel platform on the external stairs landing due to corrosion expansion of the steel.	



REF	DEFECT DESCRIPTION	PHOTO
26	Surface corrosion and grime present on external staircase landing	
27	Pitting corrosion observed on at the underside of the steel platform landing	




REF	DEFECT DESCRIPTION	PHOTO
28	Surface corrosion of one of the SHS column section supporting the steel staircase	
29	Pitting corrosion observed on PFC member	



**3.3.2 INTERNAL DEFECTS**




REF	DEFECT DESCRIPTION	PHOTO
<b>INTERNAL WALL ELEMENTS</b>		
30	Structurally failed member, potentially due to the presence of termites	




REF	DEFECT DESCRIPTION	PHOTO
31	Severe split in internal column stud member	
32	Splitting in internal column stud member	

REF	DEFECT DESCRIPTION	PHOTO
33	Severely deformed cladding on the north elevation of the structure due to vehicle impact	
34	Failure of timber studs on the north elevation of the structure due to vehicle impact	
35	Displaced timber beam due to structurally failed timber studs on the north elevation of the structure due to vehicle impact	

REF	DEFECT DESCRIPTION	PHOTO
36	Failure of timber stud on the north elevation of the structure due to vehicle impact	 <p>A photograph showing a vertical timber stud that has been crushed and buckled under load. The stud is surrounded by other structural members, and the damage is clearly visible as a significant deformation of the wood.</p>
37	Failure of timber stud on the north elevation of the structure due to vehicle impact.	 <p>A close-up photograph of a timber stud that has failed. The wood is splintered and broken. A metal bracket or plate is attached to the remaining part of the stud with bolts. A yellow and black striped safety barrier is visible in the lower-left corner of the frame.</p>

REF	DEFECT DESCRIPTION	PHOTO
38	Failure of timber studs on the north elevation of the structure due to vehicle impact.	
<b>INTERNAL TIMBER FLOORING AND CEILING</b>		
39	Missing portion of one of the timber floor beams at the underside of the first floor.	
40	Minor splitting and deterioration of the protective coating system for timber ceiling adjacent to toilet.	

REF	DEFECT DESCRIPTION	PHOTO
<b>MASONRY AND CONCRETE UPSTAND</b>		
41	Concrete missing from concrete and masonry upstand alongside corroded reinforcement on the Down Side elevation of the structure	

### 3.4 ACCESS TO THE PUBLIC AND ADJACENT RAILWAY LINE

The location of the structure in Benalla, adjacent to a vehicle and pedestrian level crossing and in a residential area, raises concerns about public safety. Despite the structure not being in service, it remains easily accessible to the general public. The pedestrian pathway to cross the level crossing leads dangerously close to the signal hut, allowing people to come within touching distance of the structure.

The residential location and ease of access to the building pose significant risks associated with the observed defects on site. The close proximity of the structure to residential areas means that any potential structural failure or collapse could endanger nearby pedestrians.

To mitigate this risk, **warning signage must be set up as soon as possible to warn of hazard and instruct not to enter**. In addition to the warning signage being installed, fencing is required to prevent access to the stairs and the doors.

### 3.5 REDUCED STRUCTURAL CAPACITY DUE TO VEHICLE IMPACT

The vehicle impact on the north face of the structure has reduced the structure's capacity to carry vertical loads by destroying 1 column, and the adjacent mullions.

As a result, we advise that sections of the signal hut are potentially unstable and pose a risk of collapse, which, given its proximity to the track, may have catastrophic consequences.

Due to the severity of the consequence should this risk eventuate we advise that propping must be installed **as soon as possible**.

## 4 RECOMMENDATIONS

The primary recommendation for the signal hut is to eliminate the potential health and safety risk to anyone who may gain access to the vicinity of the building and eliminate the train derailment risk due to debris falling on the adjacent railway tracks.

While the building is in its current condition and until demolition or dismantlement can be programmed and carried out **(which must commence within 6 months)**, it is imperative that signage is installed to warn of the hazard, and that access to the stair and the doors is restricted.

In addition to the warning signage, propping must be installed in the vehicle impacted area and the loose ridge capping must be removed, **as soon as possible**.

It is recommended to salvage the signalling lever frame, levers and any associated equipment and preserve this sympathetically with specialist advice.

In summary, it is possible to salvage some structural elements of the signal hut and to treat, test and re-purpose these.

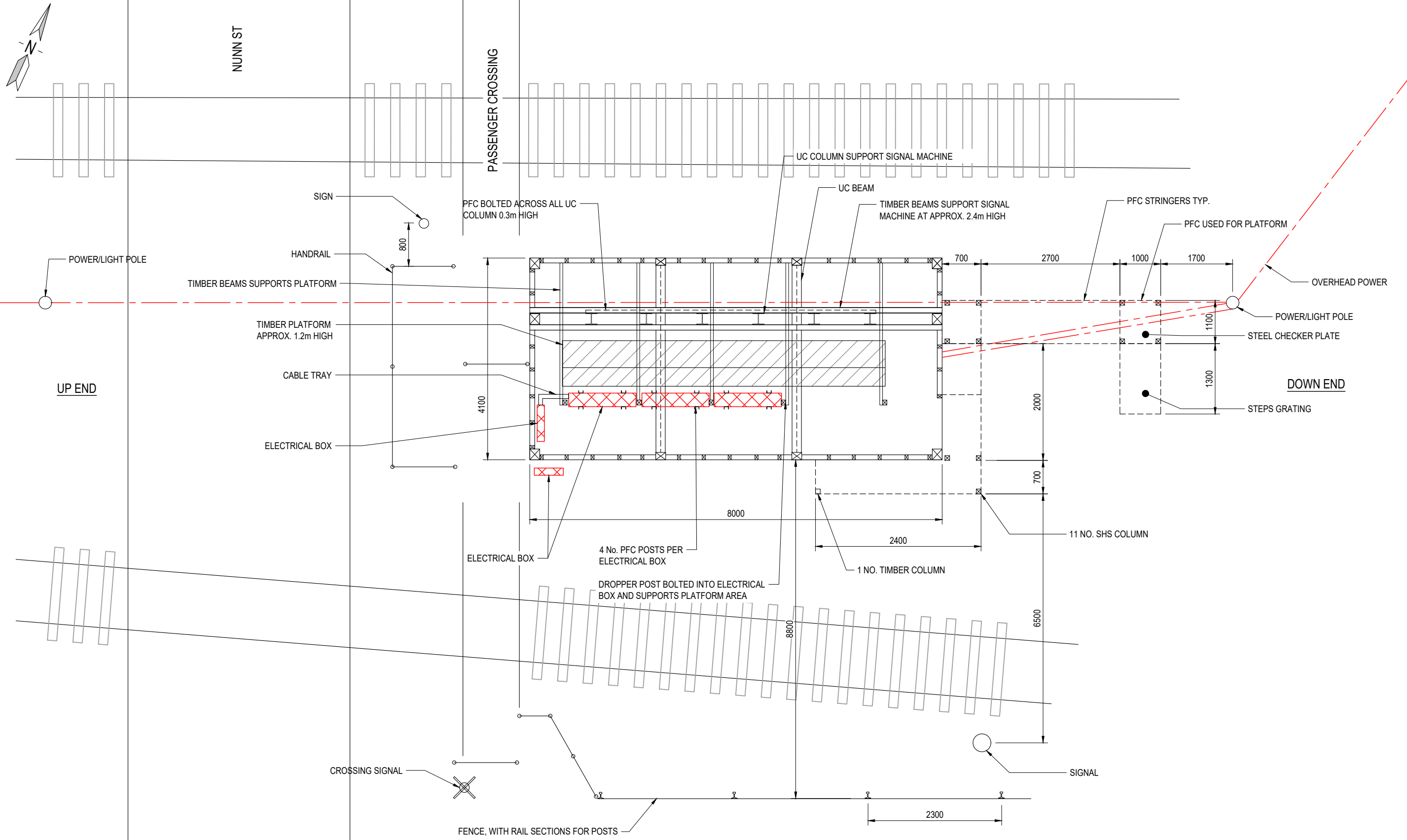
### 4.1 RECOMMENDED APPROACH

The demolition / dismantlement process for the signal hut presents several challenges due to its close proximity to live tracks operated by both ARTC and V/Line. The process will necessitate full track occupation and part road closure of Nunn Street and Mackellar Street to ensure safety and proper execution. As such, a carefully planned sequence must be prepared by a qualified engineer experienced in similar and constrained projects.

At a high level, the demolition/dismantlement is expected to proceed in the following order:

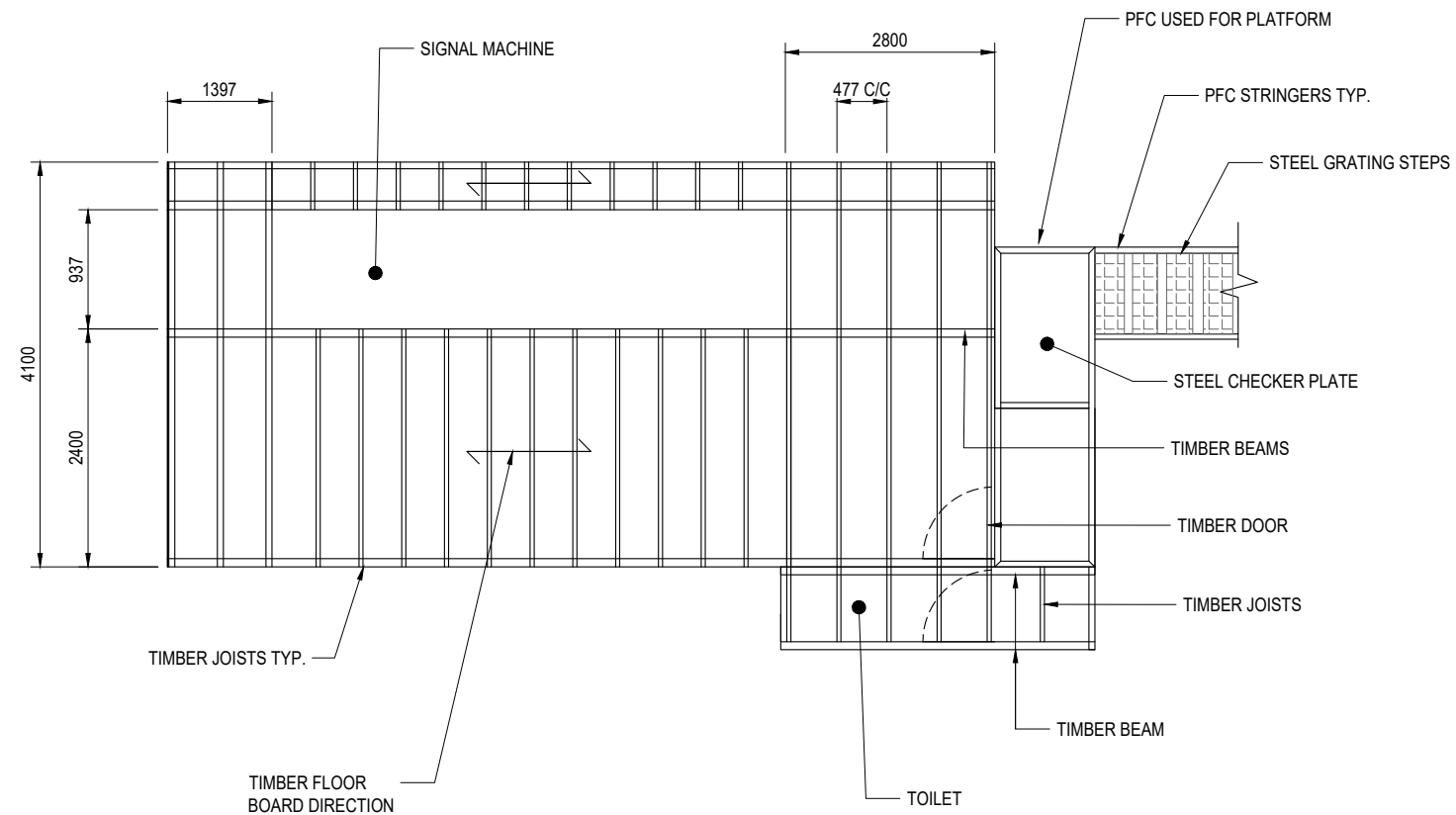
1. Install any internal bracing or structural supports identified prior to staged demolition to ensure safe operations at all times,
2. Dismantle signalling levers from Operating Floor and store for re-purpose
3. Wall cladding removal
4. Roof sheeting and ceiling removal
5. Roof truss removal
6. Timber floor and joist removal
7. Signalling lever frame removal and store for re-purpose – due to its weight it will need to be lifted vertically out of the hut ‘skeleton’ which will need temporary bracing installed. An assessment of the machine rigidity is required to confirm appropriate lifting connections.
8. Once the signal lever frame and associated equipment is carefully removed, the remaining structure can be demolished, and removed from site.
9. Salvageable segments of the signal hut could be re-purposed subject to testing.

**APPENDIX A**  
**DRAWINGS**

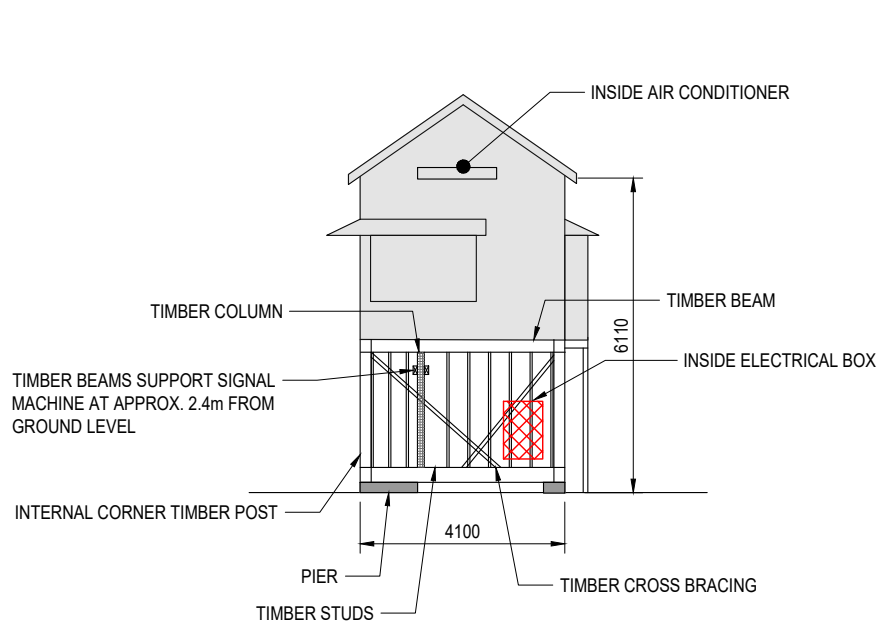


GROUND LEVEL PLAN  
N.T.S.

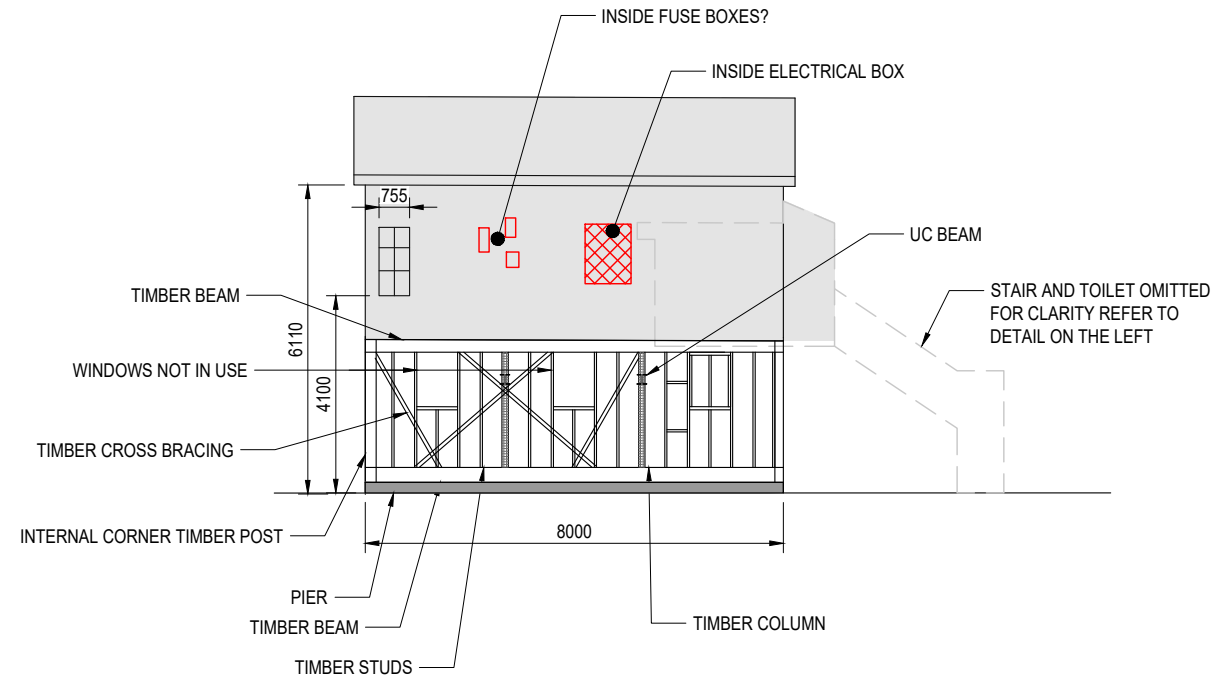




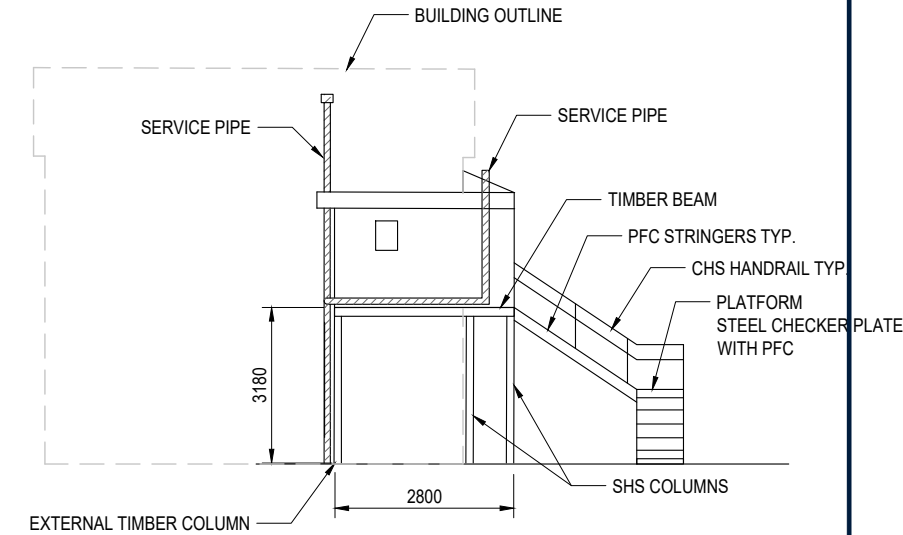
FIRST FLOOR PLAN  
N.T.S.



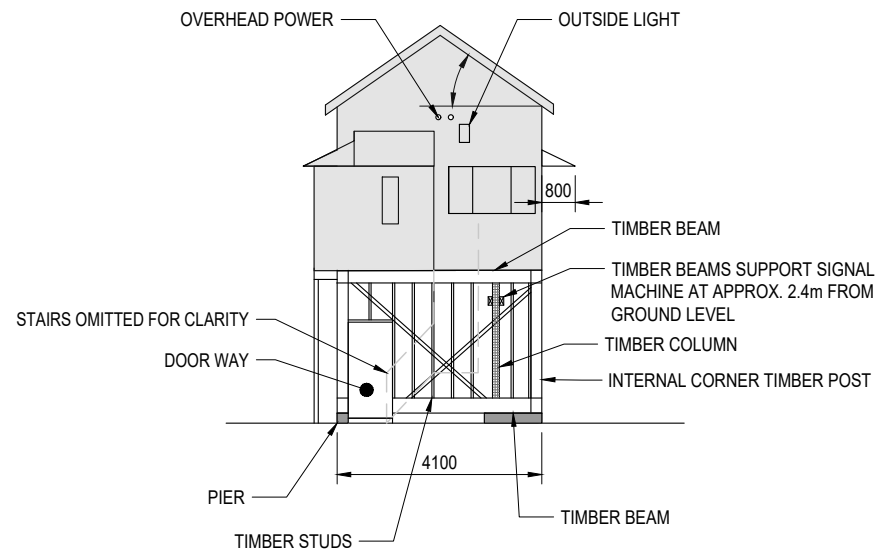
UP END  
N.T.S.



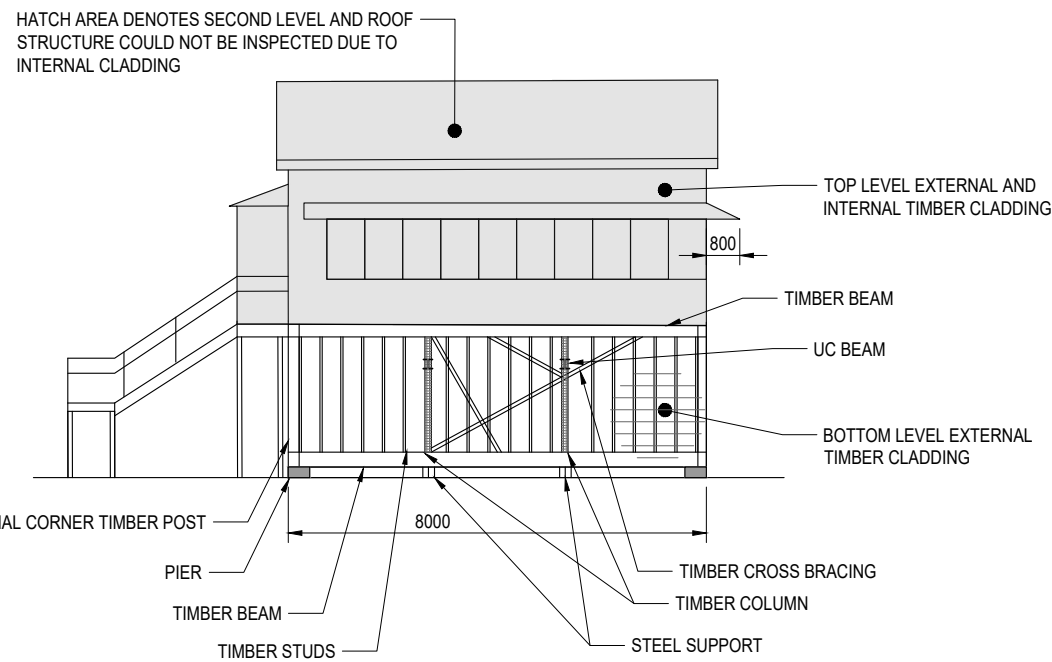
UP SIDE  
N.T.S.



UP SIDE  
VIEW OF TOILET AND STAIRS - N.T.S.



DOWN END  
N.T.S.



DOWN SIDE  
N.T.S.